

NOTE:

1. DIMENSIONS IN PARENTHESIS ARE METRIC MILLIMETERS

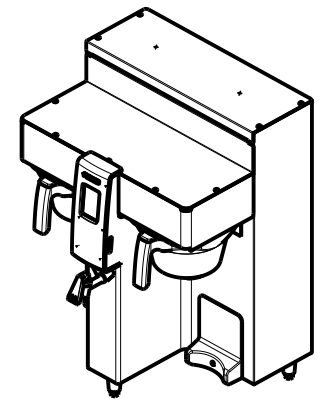

SCALE 0.063

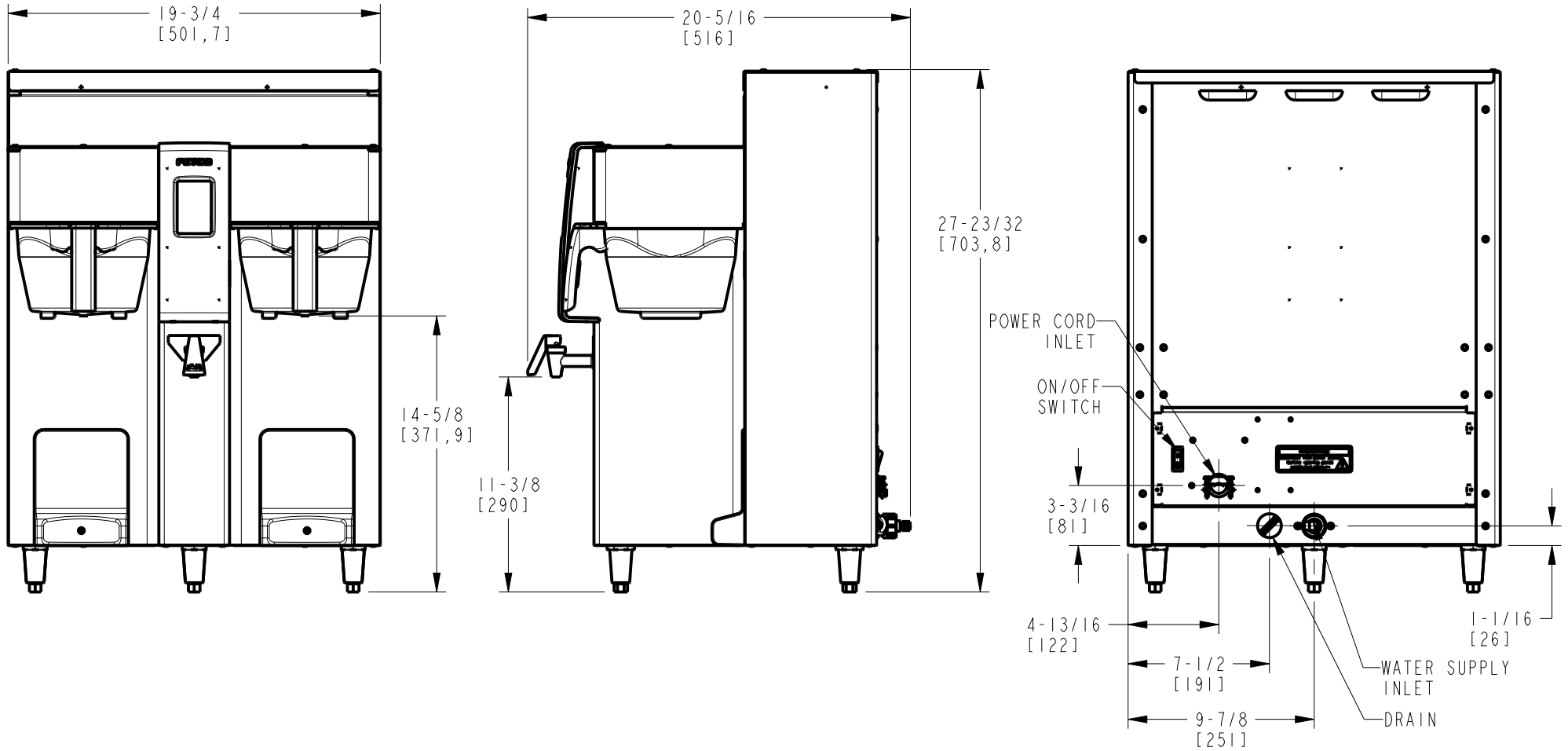

PART NO.: 1201.00014.00

SCALE: 0.125

(REV.: B)