

NOTE:

1. DIMENSION IN PARENTHESIS ARE METRIC MILLIMETERS

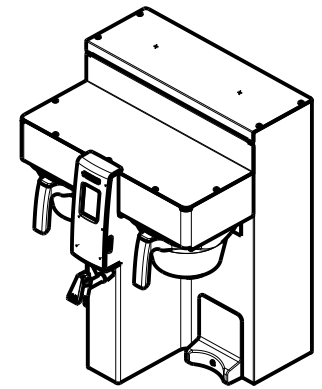

SCALE 0.063

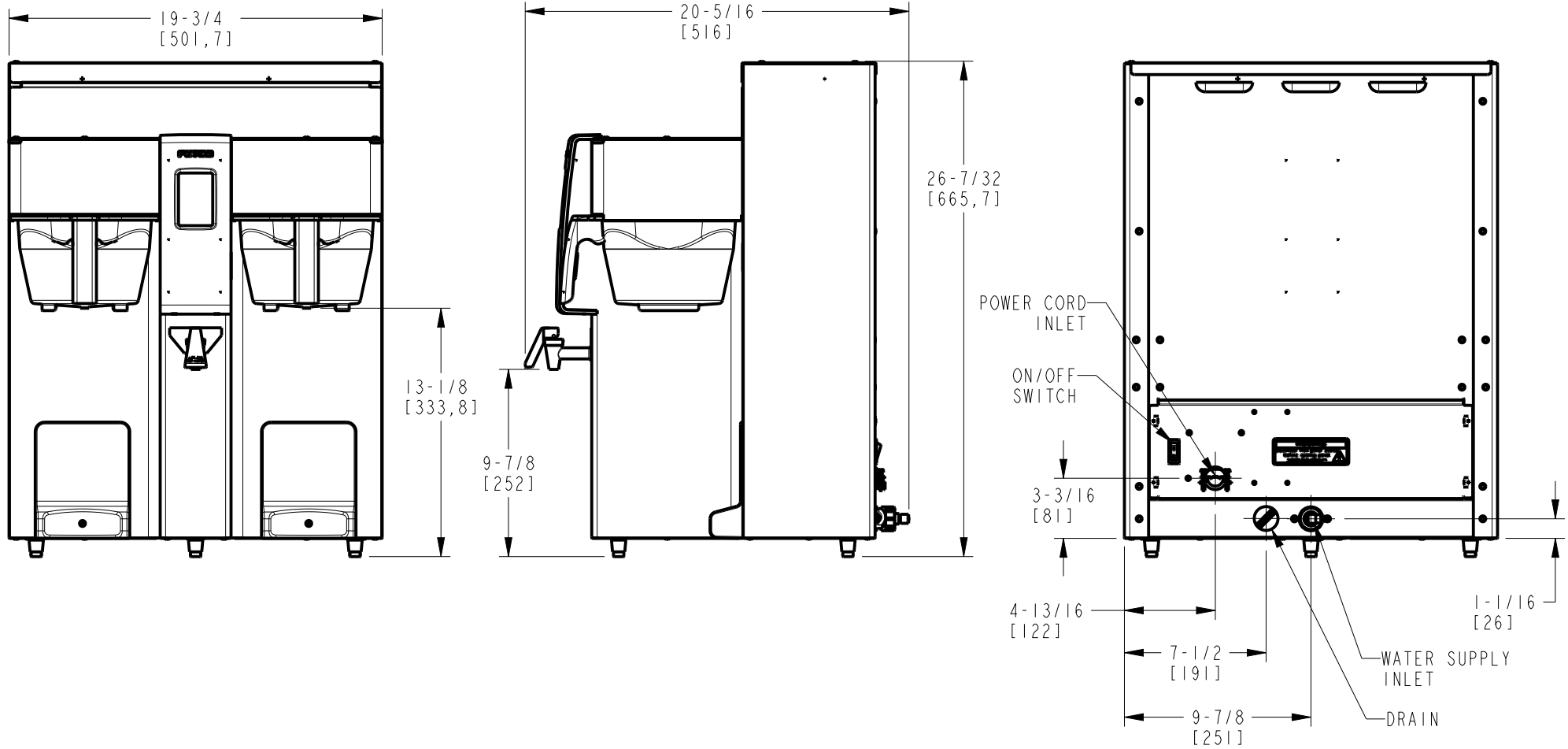

PART NO.: 1201.00012.00

SCALE: 0.125
(REV.: B)